



E-KABİN E SERİSİ

DUVAR TİPİ İÇ TESİSAT KABİNLERİ

DUVAR TİPİ İÇ TESİSAT KABİNLERİ

www.eaeelektroteknik.com



İÇİNDEKİLER

Tanıtım	3
Atölyede Kolaylık	4
Sipariş Bilgileri	6
Ön Örtü Elemanları	9
Aksesuarlar	10



E-Kabin E Serisi Duvar Tipi İç Tesisat Kabinleri

E-Kabin E Serisi İç Tesisat Kabinleri özellikle alışveriş merkezleri, oteller, hastaneler gibi binaların dahili elektrik tesisat uygulamalarına yönelik olarak tasarlanmıştır. Tasarım, DIN-ray tipi cihazların kullanımına müsaade etmektedir.

Kullanım yeri	: dahili
Koruma sınıfı	: IP 55
Montaj şekli	: duvar tipi, dikili tip
Boya	: epoksi - polyester toz boya
Renk	: standart RAL 7035
Çevre şartları sınıfı	: EN 60721 - 3 - 3'e göre IE32
Uygun olduğu standartlar	: IEC 61439-1, IEC 62208 IEC 60529, IEC 62262

ATÖLYEDE KOLAYLIK

Kapı içi profilleri

Kapağın mukavemetini arttıran kapak içi profilleri, kablo vb. bağlantı ekipmanlarının da takılmasını sağlar.



Poliüretan conta

Kapı üzerine yerinde dökülen poliüretan conta zamanla esnekliğini kaybetmez, toz ve suya karşı koruma sağlar.

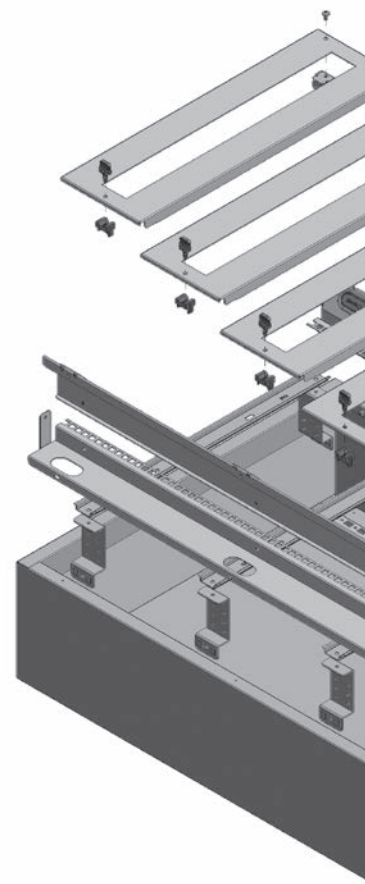

Camlı Kapı Uygulaması

İsteğe bağlı olarak temperli camlı kapı seçilebilir.



Kullanışlı kilit sistemi

Anahtar istenildiğinde üzerinde kalabilen kilit sistemi.



Planlama kolaylığı

Standart genişlik ölçüsü sayesinde her bir sırada 24 / 36 adet 18 mm birim genişliğinde cihaz kullanılabilir.

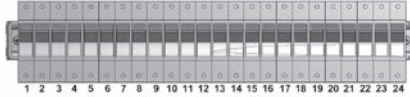

24 Birim - 60 cm anma genişliğinde
36 Birim - 80 cm anma genişliğinde

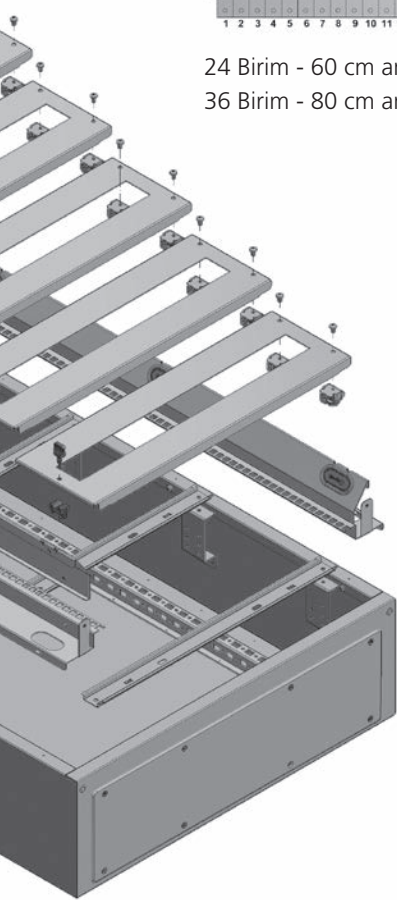

180° açılabilir kapı

Kapı standart menteşe ile 180° açılabilir ve içinde çalışması gereken durumlarda kolaylık sağlar.

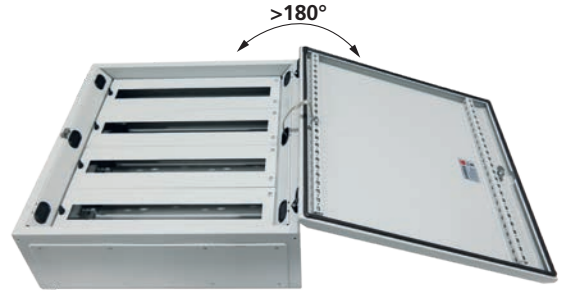

Kapı altında derin ara bölge

Kapı ile örtü plakaları arasında bulunan 70 mm'lik boşluk kapı üzerine ölçü aleti, paket şalter vs. montajına müsaade etmektedir.

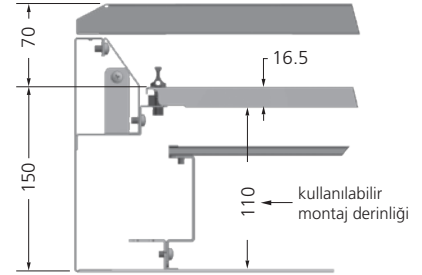

Kullanışlı braket

Braket takımı ile kutunun duvara montajı kolay ve hızlı bir şekilde yapılabilir.







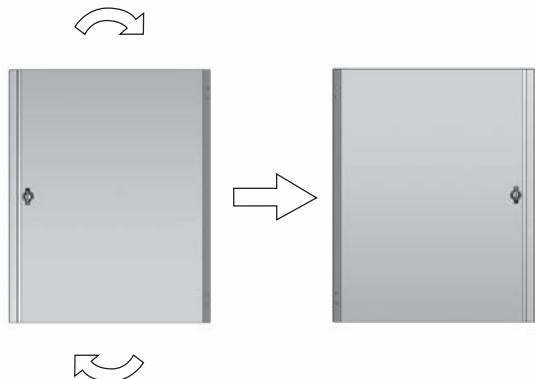

Değiştirilebilir kapı açılma yönü

İhtiyaç duyulduğunda kapı açılma yönü değiştirilebilir.



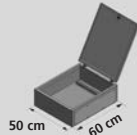

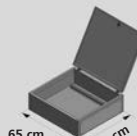

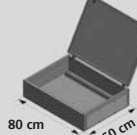
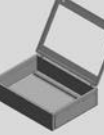
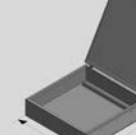
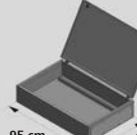
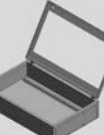
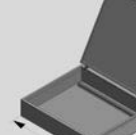
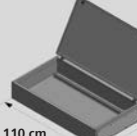
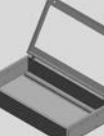
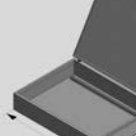
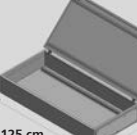
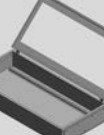
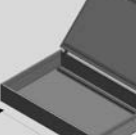
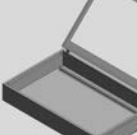

Aksi belirtilmemişse ölçüler mm'dir.

SİPARİŞ BİLGİLERİ



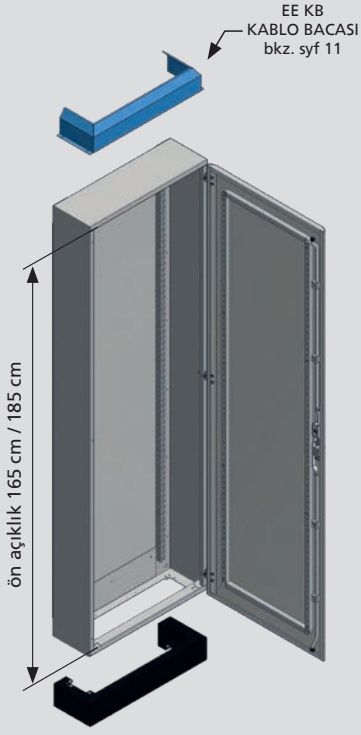



DUVAR TİPİ				
	60 cm GENİŞLİĞİNDE		80 cm GENİŞLİĞİNDE	
	DÜZ KAPI	CAM KAPI	DÜZ KAPI	CAM KAPI
35x60x22 cm	 35 cm 60 cm EE 035 06 D0	 EE 035 06 C5		
50x60x22 cm	 50 cm 60 cm EE 050 06 D0	 EE 050 06 C5		
65x60x22 cm	 65 cm 60 cm EE 065 06 D0	 EE 065 06 C5		
80x60x22 cm	 80 cm 60 cm EE 080 06 D0	 EE 080 06 C5	80x80x22 cm	 80 cm 80 cm EE 080 08 D0
95x60x22 cm	 95 cm 60 cm EE 095 06 D0	 EE 095 06 C5	95x80x22 cm	 95 cm 80 cm EE 095 08 D0
110x60x22 cm	 110 cm 60 cm EE 110 06 D0	 EE 110 06 C5	110x80x22 cm	 110 cm 80 cm EE 110 08 D0
125x60x22 cm	 125 cm 60 cm EE 125 06 D0	 EE 125 06 C5	125x80x22 cm	 125 cm 80 cm EE 125 08 D0
				 EE 125 08 C5

YER VE DUVAR TİPİ

60 cm GENİŞLİĞİNDE

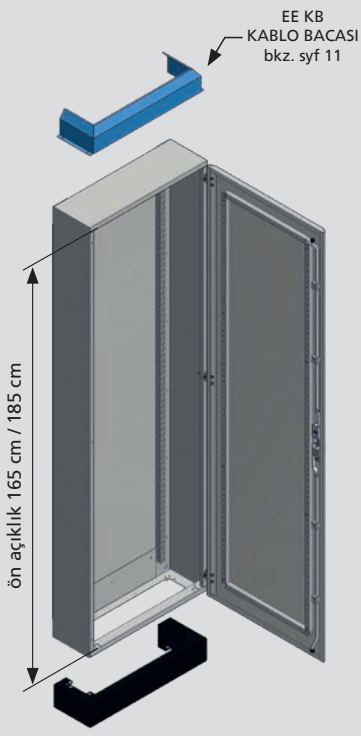
	DÜZ KAPI	MONTAJ PLAKASI	ÖN ÖRTÜ PROFİLLERİ	
180x60x22 cm	 EE 180 06 D0	 EE MK 180 06	 EE CT 180	 <p>EE KB KABLO BACASI bkz. syf 11</p> <p>ön açıklık 165 cm / 185 cm</p> <p>Ürün içeriğine baza dahildir.</p>
200x60x22 cm	 EE 200 06 D0	 EE MK 200 06	 EE CT 200	

80 cm GENİŞLİĞİNDE

	DÜZ KAPI	MONTAJ PLAKASI	ÖN ÖRTÜ PROFİLLERİ	
180x80x22 cm	 EE 180 08 D0	 EE MK 180 08	 EE CT 180	 <p>EE KB KABLO BACASI bkz. syf 11</p> <p>ön açıklık 165 cm / 185 cm</p> <p>Ürün içeriğine baza dahildir.</p>
200x80x22 cm	 EE 200 08 D0	 EE MK 200 08	 EE CT 200	

MONTAJ PLAKASI VE SETİ

EE MONTAJ PLAKASI SETİ		
h \ g	60 cm	80 cm
5 cm	EE MP 0506	EE MP 0508
15 cm	EE MP 1506	EE MP 1508
20 cm	EE MP 2006	EE MP 2008
30 cm	EE MP 3006	EE MP 3008

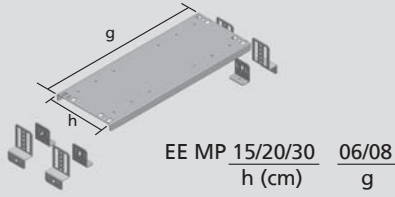
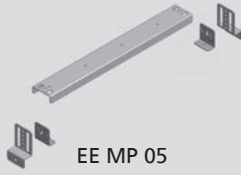

EE MK BOY MONTAJ PLAKASI

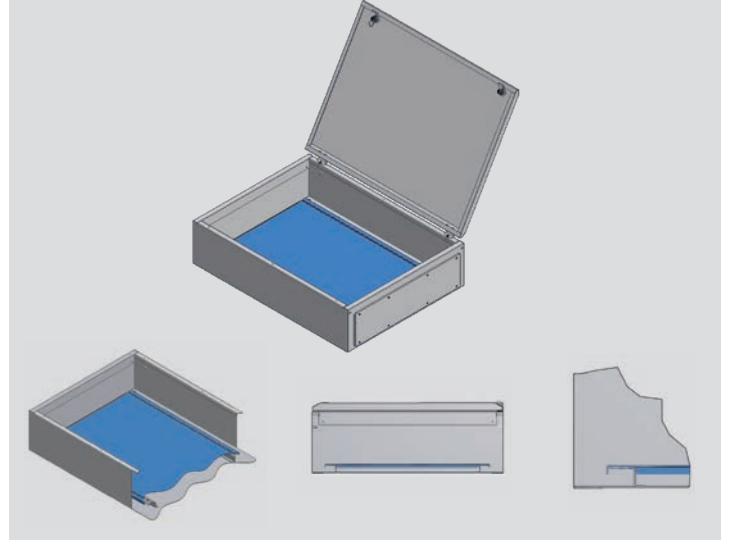

EE MK BOY MONTAJ PLAKASI



















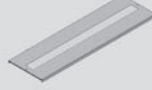



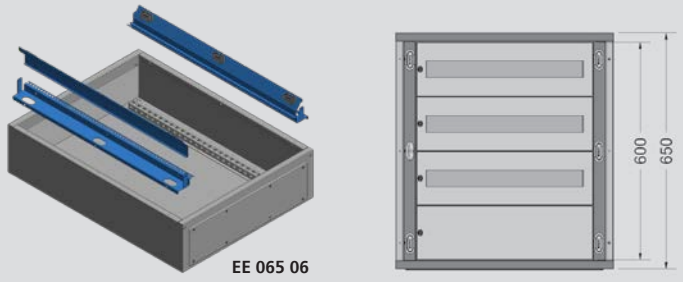





h \ g	60 cm	80 cm
35 cm	EE MK 035 06	
50 cm	EE MK 050 06	
65 cm	EE MK 065 06	
80 cm	EE MK 080 06	EE MK 080 08
95 cm	EE MK 095 06	EE MK 095 08
110 cm	EE MK 110 06	EE MK 110 08
125 cm	EE MK 120 06	EE MK 125 08

RAY MONTAJ SETİ - Ray dahil

24 Ünite / 60 cm	24 Ünite / 60 cm	36 Ünite / 80 cm
<p>EE RSS 06 Sac ray</p>	<p>EE RSA 06 Alüminyum ray</p>	<p>EE RSA 08 Alüminyum ray</p>

Aksi belirtilmemişse ölçüler mm'dir.

ÖN ÖRTÜ ELEMANLARI

YÜKSEKLİK	STANDART ÖN ÖRTÜ ELEMANLARI					
	Anma Genişlik		YARIKLI ÖN ÖRTÜ ELEMANLARI			
	60 cm	80 cm	24 Ünite / 60 cm	36 Ünite / 80 cm		
10 cm	 EG OM 1006	 EG OM 1008	 EG OM 1506A	 EG OM 1508A		
15 cm	 EG OM 1506	 EG OM 1508				
20 cm	 EG OM 2006	 EG OM 2008	 EG OM 2006A	 EG OM 2008A		
25 cm	 EG OM 2506	 EG OM 2508				
30 cm	 EG OM 3006	 EG OM 3008	ÖN ÖRTÜ PROFİLLİ UYGULAMA ÖRNEĞİ EE CT 065 			
35 cm	 EG OM 3506	 EG OM 3508				
45 cm	 EG OE 4506	 EG OM 4508				
55 cm	 EG OM 5506	 EG OM 5508	ÖN ÖRTÜ PROFİLLERİ			
65 cm	 EG OM 6506	 EG OM 6508	 EE CT 035	 EE CT 050	 EE CT 065	 EE CT 080
			 EE CT 095	 EE CT 110	 EE CT 125	

Aksi belirtilmemişse ölçüler mm'dir.

AKSESUARLAR

Taşıyıcı bölme elemanı
EE TB 06 60 cm Genişlik için
EE TB 08 80 cm Genişlik için

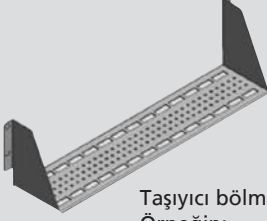

Taşıyıcı bölme elemanı farklı amaçlarla kullanılabilir.
Örneğin;
- kompanzasyon uygulamalarında kondansatör taşıyıcı olarak,
- kuvvetli akım besleme ve zayıf akım güvenlik devreleri gibi farklı işlevleri olan devre grupları arasında bölmelendirme yapmak amacıyla.

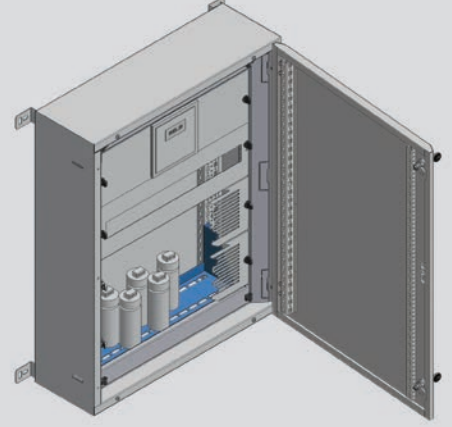

EE MP Montaj Plakası derinlik ayar ölçüleri

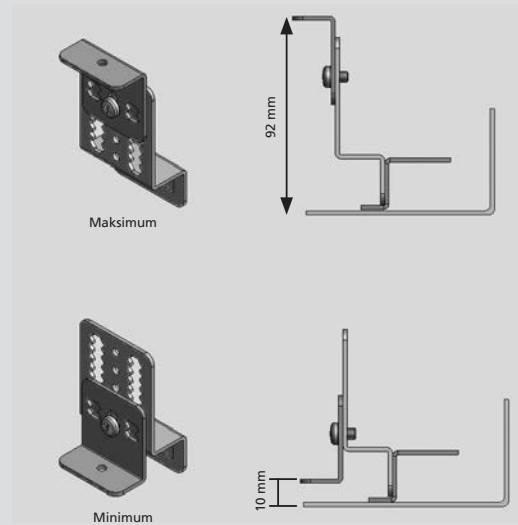
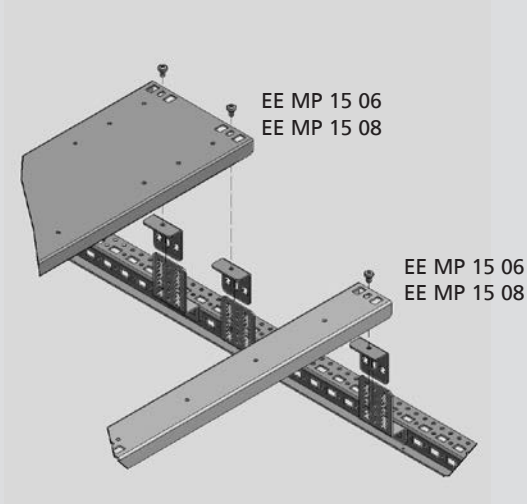

Tüm sipariş kodları için bkz. s.8

Örnek uygulama

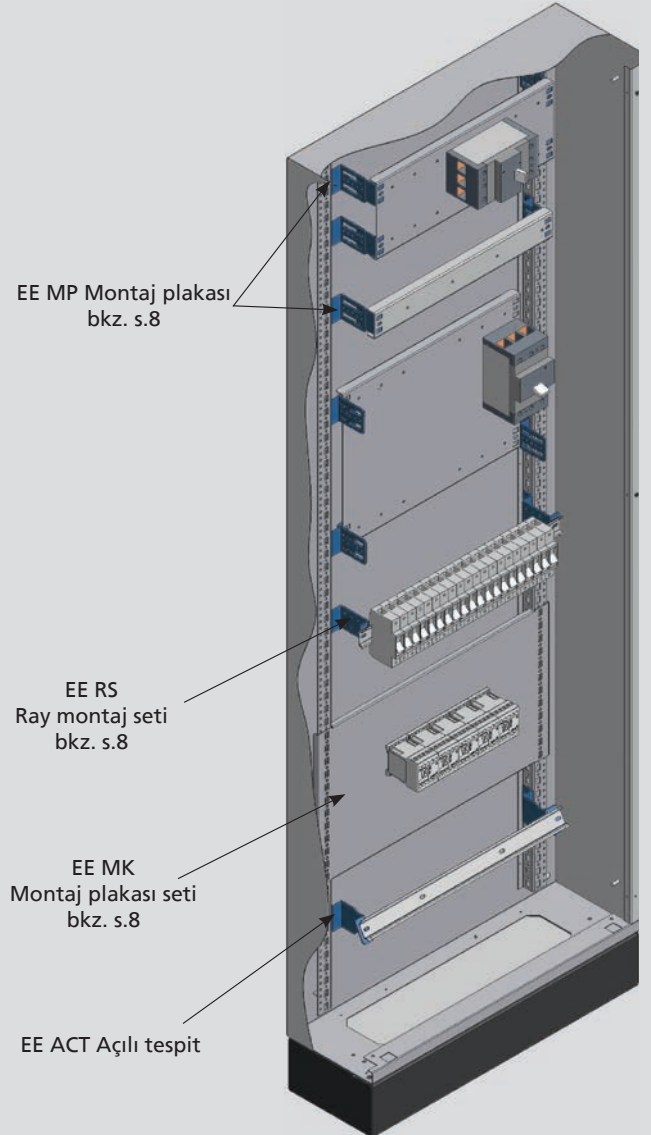

Duvara montaj profil seti

EE DM 035
EE DM 050
EE DM 065
EE DM 080
EE DM 095
EE DM 110
EE DM 125
EE DM 180
EE DM 200

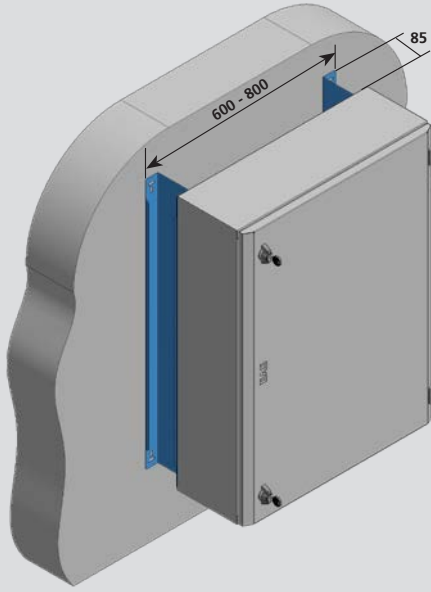

Kablo Bacası

EE KB 06 60 cm Genişlik için
EE KB 08 80 cm Genişlik için

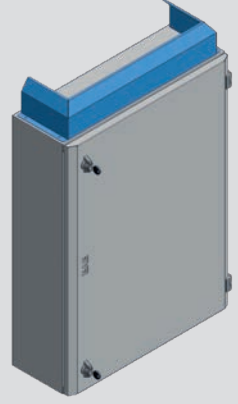

Sac Proje Cebi

EE PC 06 60 cm Genişlik için
EE PC 08 80 cm Genişlik için

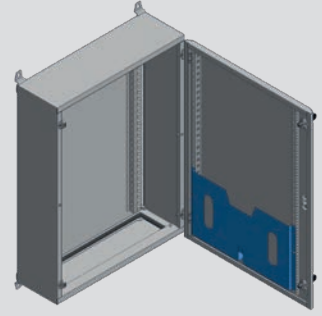

Kabin birleştirme seti

EE PB 01



üst üste

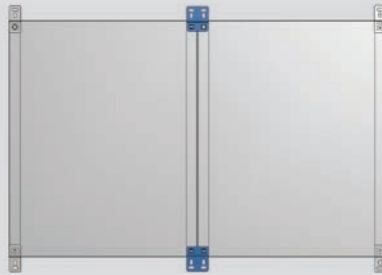

yan yana

Set içeriği

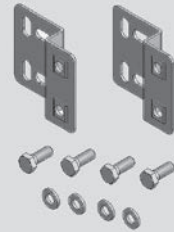



Kataloglarımızın en güncel hali ve sertifikalarımız için lütfen web sayfamızı ziyaret ediniz.

www.eaelektroteknik.com/destek/indirme-merkezi



www.eaelektroteknik.com

EAE Elektroteknik A.Ş.

İkitelli Organize Sanayi Bölgesi

Eski Turgut Özal Caddesi

Ziya Gökalp Mahallesi No: 20

34490 Başakşehir / İstanbul

Tel : +90 (212) 549 26 39 (pbx)

Faks : +90 (212) 549 37 91

E-mail: ekabin@eae.com.tr